



Model: E2
ID: LSWE22 (2 gang)

ENGLISH

MLSE204

iotty Smart Switch
Model: E2
ID: LSWE22 (2 gang)
Input 230 Vac
Frequency 50Hz
Max 5A per RL
Ambient temperature: 25°C
Operating temperature: from 0°C to 40°C
Only works with 2.4GHz Wi-Fi band

Frequency range: 2412-2472MHz
Maximum RF output power
of the product: 17.29 dBm

RF exposure information:
The Maximum Permissible Exposure (MPE) level is calculated based on a distance of $d=20$ cm between the device and the human body. To maintain compliance with the RF exposure requirement, a separation distance of 20 cm between the device and the human should be maintained.

Warranty

For warranty information visit us at www.iotty.com/warranty

IOTTY srl
Via Del Laghetto, 18/20
33080 Porcia (PN) - ITALY
iotty@iotty.com
support@iotty.com

Input L/N should be connected to a 16A circuit breaker, and each way output should be connected to a 5A circuit breaker before used.

Important Notes

Safety Precaution

Install in accordance with all national and local codes.

Hire a professional electrician if you are not familiar or not comfortable with electrical work, or if the wiring in your electrical box looks different from the pictures.

For indoor use and dry location only.

Installation Precaution

Neutral wire required.

About 3-way

3-way switch is the type of the switch that allows to control an electrical load from 2 different locations.

Thanks to the Multi-way feature, you can connect multiple iotty switches together through the Wi-Fi network to control the same light

For more details check www.iotty.com/multi-way

Troubleshooting

1. In case the switch or the touch doesn't work, reset the switch in this order:

- From the app (soft reset) [Device settings > Reset device],
- OR
- By powering off the circuit breaker.

2. In case of network error, try these steps in order:

- Restart the router,
- OR
- Remove the faceplate and push the Reset button on the switch.
- OR
- Remove the faceplate and push the AP button on the switch. Repeat device registration (see point 6 of instructions).

Restore the touch sensitivity with a soft reset every time you put the faceplate back to place (see point 1 of troubleshooting).

Overview of the iotty Smart Switch

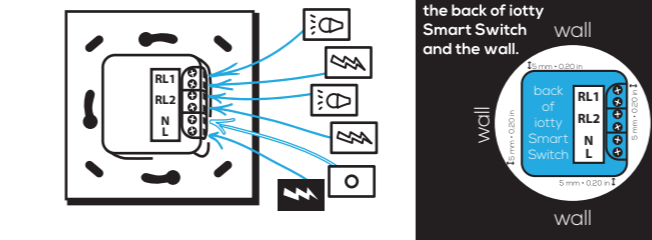
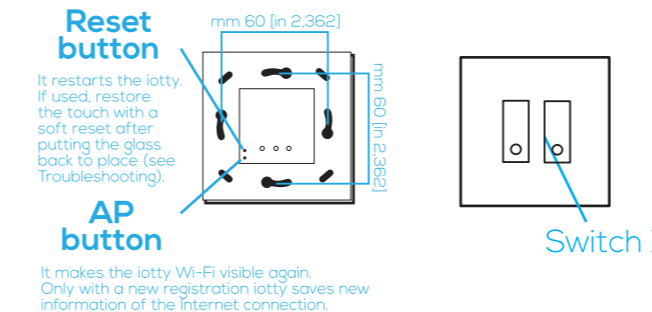

All instructions for installation
on the other side of this manual.

In case loads operate at a different voltage from iotty's:

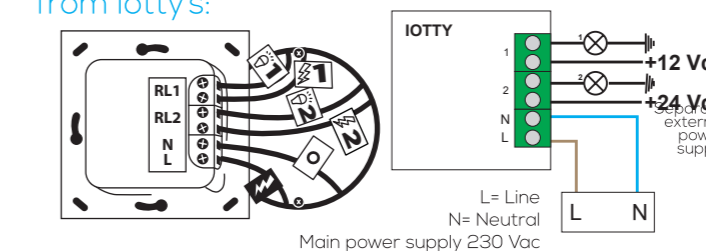

In case loads need a pulse to activate:

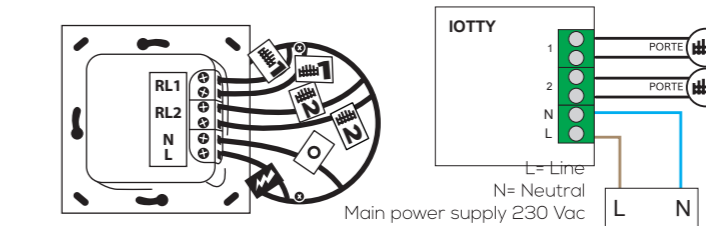

To set the switch properly, go to the iotty app, go to Device Settings and under "Gang Type" select "Gate".

In case loads operate at a different voltage from iotty's:

More info at:
www.iotty.com

WARNING: Electrical wirings should be done by a professional electrician. Incorrect installation is dangerous or illegal. Please call a professional electrician if you are unfamiliar or uncomfortable with electrical work.

Read the **Important Notes** on the other side of this manual before starting the installation.

1

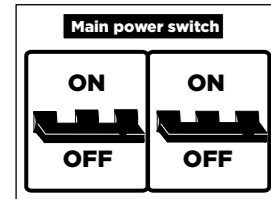

Turn off the power at the circuit breaker for the switch you are replacing.

2

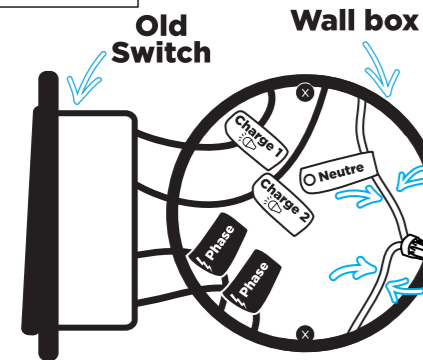

Remove your old switch and label your wires. Remember that you must have a neutral wire to install iotty Smart Switch.

3

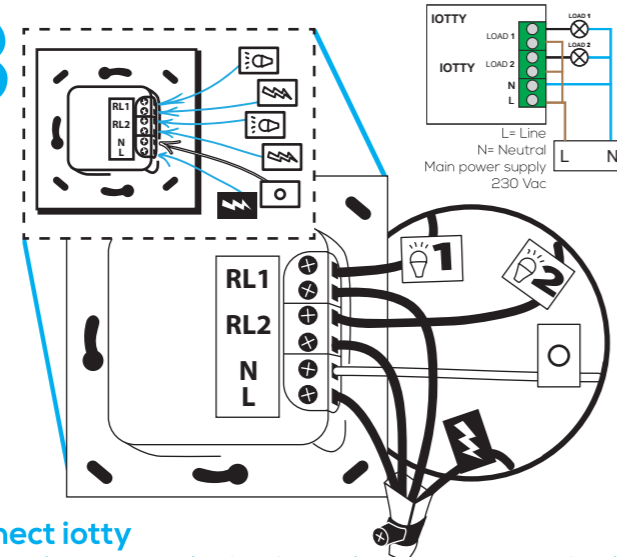

Connect iotty

Insert the neutral wire into the screw terminal labeled with N. Insert the line into the screw terminal L. Insert the line and the load into the screw terminals of RL1 and RL2. If you have a ground wire, place it into the wall box.

Input L/N should be connected to a 16A circuit breaker, and each way output should be connected to a 5A circuit breaker before used.

4

Screw in iotty

○ = recommended screw holes

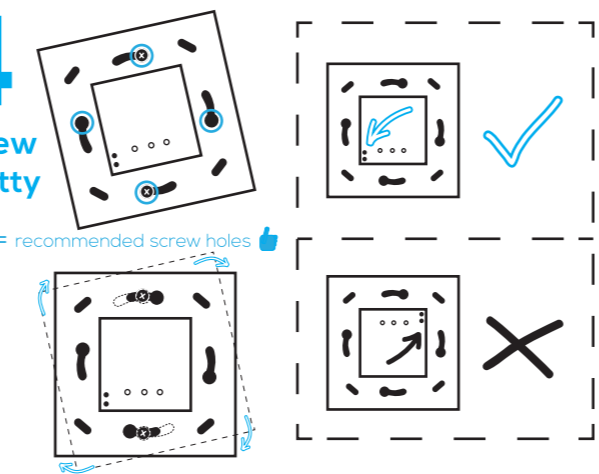

Push all the wires back into the wall box and try to allow as much space for the switch as possible. (Do not push the wires using the back of the switch). Insert the iotty Smart Switch in the wall box screws. Position the switch so that the buttons are located at the bottom.

5

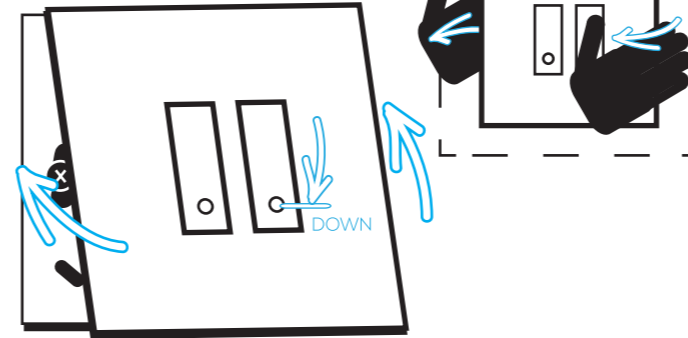

Attach your iotty Smart Switch faceplate.

To remove, use your hands to lift the faceplate. Position the faceplate so that the little circle is located at the bottom.

6

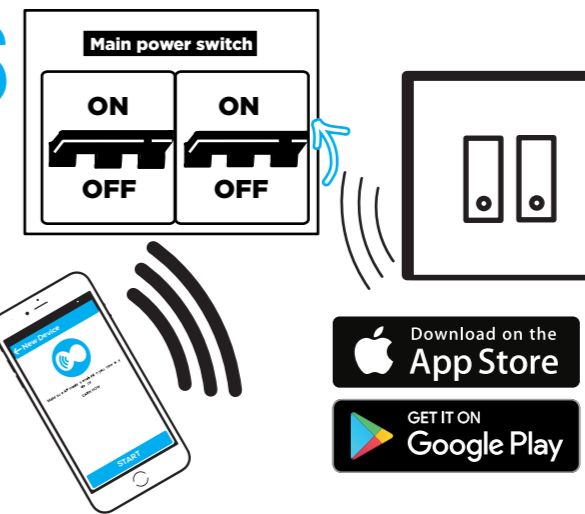

Turn on the power at the circuit breaker. Download the iotty app and sign in. Connect to your iotty Smart Switch Wi-Fi [IOTTY_serial-number]. Now go to the app and **add a new device**.



To enable the iotty skill in Alexa:

Login to your personal Alexa page (either in your browser, or in the Alexa mobile App), and tap "Smart Home" in the menu. Tap on "Enable smart home skills", then search for "iotty Smart Home". Tap on "Enable", and follow the instructions. You will need to enter your iotty username and password.



To enable iotty in the Google Assistant app

Make sure that the "Home control" service is enabled in your Google account. Enter your Google Assistant settings in Google app menu, then tap "Home control". Tap the '+' icon to add device, then select "iotty". Follow the instructions. You will need to enter your iotty username and password.

WARNING: Electrical wirings should be done by a professional electrician. Incorrect installation is dangerous or illegal. Please call a professional electrician if you are unfamiliar or uncomfortable with electrical work.